



**bassra**  
machine **tools** ltd

**PRODUCT  
CATALOGUE  
2012**



Bassra Machines

# About Us

Bassra Machine Tools UK has been providing quality solutions to customer since 1983. Its been a leader in the filed of Glass Insulating lines, Glass Washing lines and Glass Cutting tables and lines. We give particular attention to innovations required by the market as well as to the customized automations in compliance with all initiative required towards energy saving. Our technical staff and sales staff together forms a good team to provide solutions to customers all over the world. Our aim to provide British technology at Affordable price has enabled us to have customers in 31 countries. Our customers have always appreciated that we used standard parts, which they can buy off the shelf from their local supplier in any country. Machines are so easy to maintain that customers can easily maintain themselves.

BMT Machines India Pvt. Ltd. has been formed in 2008 as an extra shoot coming out of the roots of its parent company Bassra Machine Tools Ltd. With growing demands of our machines in Asia we decided to set up a factory in India rather than in china to establish a better quality and service solution to our customers in Asia and Middle East at reasonable cost.. BMT Machines India have all engineers capable to speak in English and hence communication with the customers and its parent company in UK becomes easier and faster. All major Important parts used are coming from Europe or bought from the European companies established in India. Continuous supervision of Quality and Production by Bassra Machines UK team on daily basis and monthly visits gives an extra edge to this company to have very high UK quality produced in India.



# PANEL PRESS LINE

## INSULATING TECHNOLOGY

Bassra Machine Tools Ltd.  
99 Spring Road, Tysley, Birmingham  
B11 3DJ, United Kingdom  
Tel :- +44-121-7074343, Fax :-+44-121-7073535  
Email :- [cjk@bassra.com](mailto:cjk@bassra.com), [sales@bassra.com](mailto:sales@bassra.com) , Website :- [www.bassra.com](http://www.bassra.com)



# BMT Automatic Panel Press Line



## Technical Data

The structure of the machine is very strong and robust

All parts touching water are made of non-corrosive material like SS, Plastic or Rubber. Motorized Inlet and Outlet Conveyor with both having black back panels

The motors for Brushes and Drive conveyor are outside and very easy to approach for any maintenance.

### • Inlet and Outlet unit : -

Automatic drives which pushes the glass in and pulls the glass out of the washer automatically.

Outlet Conveyor has inspection lights and a sensor at the end

### • Washing and drying unit :-

Machine is prepared to accept demineralized water/ RO Water.

Washing is done by Cylindrical brushes which works at High speed and spray the water uniformly.

Brushes are having big diameter and have inward adjustment on bearing housing which means after some wear and tear you can make the brushes go inwards and hence its life long lasting.

Brushes are very easy to replace which can be done by any operator without any help or guidance.

All Front Brushes are Soft Brushes and are capable to wash Low E Glass

Each pair of brushes have a separate water tank compartment with separate pump and filter.

Water Tanks are fitted with Heaters for Hot Water for better cleaning of glass.

Water tank fitted with float valve for controlling the water level it shows a light when the water level is low.

Water tanks are easy to detach, drain water and clean.

Drying is done by special air knives which are connected to high Pressure fan.

Fan sits inside a sound insulated Enclosure which meets the standards.

- Options :-
- Hot air drying facility for better and fast drying (OPTION)
  - Brush Speed Control System
  - Brushes moving backward with Pneumatic Cylinder to enable to wash Special Low E Glass.





#### • Assembly Rack :-

This unit is there for the use of aluminium spacer bar. The second Glass comes here and the spacer frame is applied here before it goes to panel press unit. Right angling unit enabling easy placement of the spacer profiles.

#### • Panel press :-

It is Fully Controlled by PLC for all its functions and sequence. The machine has touch screen system which displays all parts of line and its sensors which enables anyone to do fault finding. Display system shows operation of the line in text format on one of the screen in the program. Pressing function is done by Flat Panel. Suction pads inside the machine is used to pick the glass and place it in right position. Alignment of two/three pieces of double or triple glass or step glass is done inside the press automatically.

Homogeneous Pressing is done automatically for the right time required according to the size of glass as this is already in the program of PLC recipe. The machine can work on manual mode also to enable it to press oversized glass sheets.

Machine is capable of doing double and triple glazed units and step glass function is available as option.

#### • Tilting table :-

Motorized rack which has tilting facility. It has round wheels which is used for easy movement of glass unit in horizontal position to unload big pieces or to transport to sealing table or castor table for the next step which is secondary sealing.

#### Options :-

- Extra racks for enabling machine to increase the production capacity as more units will be waiting on those racks which one is already in press
- Step Glazing Function.

# BMT Automatic Panel Press Line

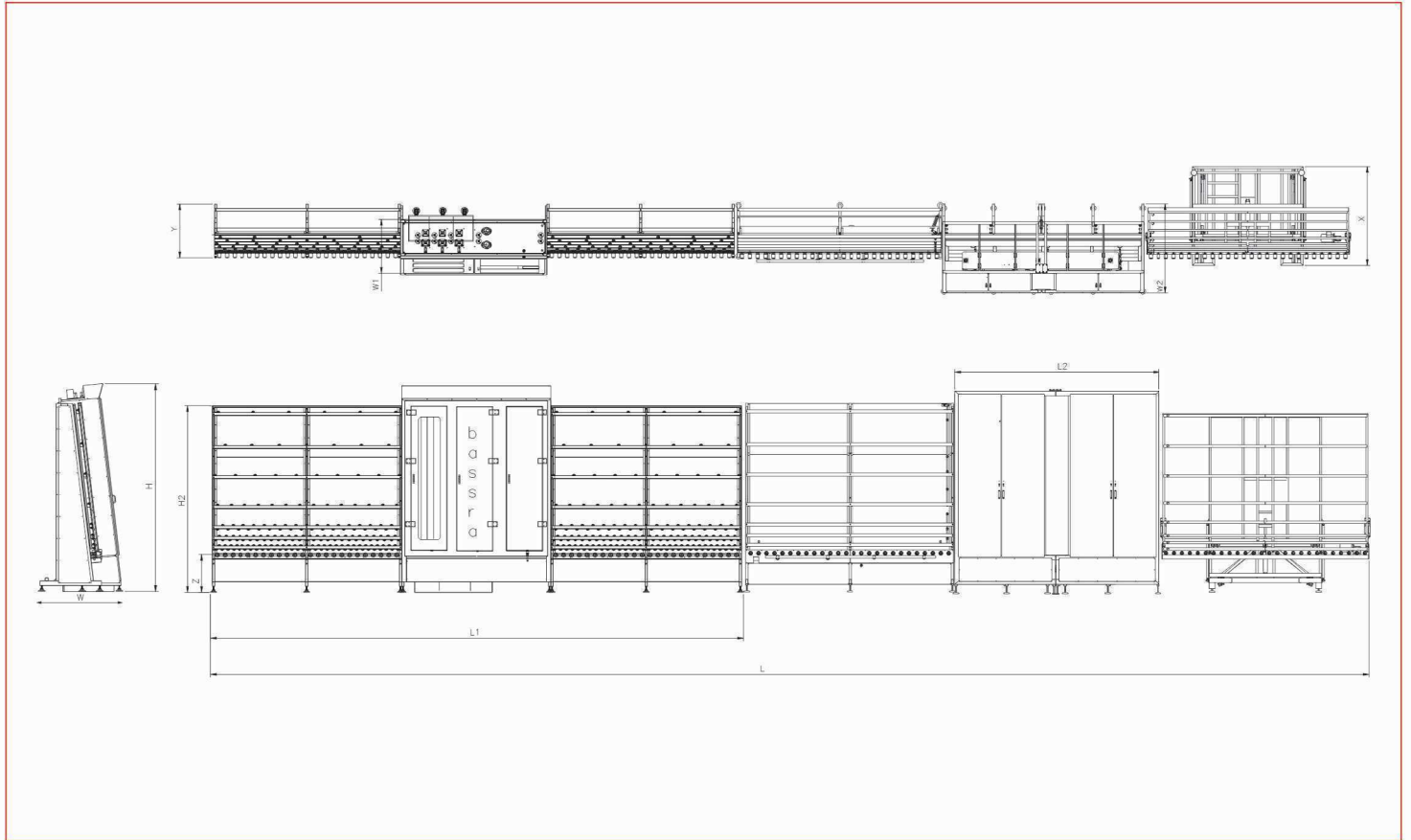

MACHINE MODELS		BMT-1.7-4-APPL	BMT-1.7-6-APPL	BMT-2.0-4-APPL	BMT-2.0-6-APPL	BMT-2.5-6-APPL
OVERALL DIMENSIONS IN MM	L	17150	17800	17150	17800	19720
	W	2200	2200	2200	2200	2700
	H	2700	2700	3000	3000	3500
	L1	8150	8790	8150	8790	9070
	W1	930	930	930	930	930
	L2	2980	2980	2980	2980	3480
	W2	1540	1540	1540	1540	1540
	H2	2375	2375	2675	2675	3175
	X	1710	1710	1710	1710	1710
	Y	930	930	930	930	930
Z	640	640	640	640	640	
WEIGHT		4800 KG	5100 KG	5200 KG	5500 KG	6000 KG

All details mentioned on this brochure are subject to change at any time. Our standard term & condition apply.





Conveyers have Special Rollers made of Poly Urethane which has long life and very easy to change.  
Conveyer Speed has a speed controller which is used to increase or decrease the speed.



Panel press unit has touch screen panel, homogenous pressing by flat press. Double triple and step glazing (option) is possible.

✓ Standard    ✗ NA    + Option

	BMT-1.7-4-APPL	BMT-1.7-6-APPL	BMT-2.0-4-APPL	BMT-2.0-6-APPL	BMT-2.5-6-APPL
<b>OPERATING DATA</b>					
Max height of the Glass	2700mm x 1700mm	2700mm x 1700mm	2700mm x 2000mm	2700mm x 2000mm	3000mm x 2500mm
Min Glass Size	360mmX170mm	360mmX170mm	360mmX170mm	360mmX170mm	360mmX170mm
Air Pressure	7 bar	7 bar	7 bar	7 bar	7 bar
Voltage	400 V 3NPE	400 V 3NPE	400 V 3NPE	400 V 3NPE	400 V 3NPE
Total Power	17.5 KW	18 KW	25 KW	27 KW	32 KW
No. of Brushes	4	6	4	6	6
Open Top	✓	✓	✗	✗	✗
Speed of Washer	6m/min	6m/min	6m/min	6m/min	6m/min
Speed Control System on Conveyer	✓	✓	✓	✓	✓
Pre Rinse Section	✓	✓	✓	✓	✓
Brush Adjustment Backward for Special Soft Low E glass	+	+	+	+	+
Brushes with Speed Control system	+	+	+	+	+
Can Wash Low E Glass	✓	✓	✓	✓	✓
No. of Low E Brushes	2	3	2	3	3
No of Compartments in Water Tank	2	3	2	3	3
Hot Water Cleaning	✓	✓	✓	✓	✓
Sensors on all Racks	✓	✓	✓	✓	✓
Lights for Inspection	✓	✓	✓	✓	✓
Max.unit thickness	60 mm	60 mm	60 mm	60 mm	60 mm
Double and Triple Glass	✓	✓	✓	✓	✓
Step Glass	+	+	+	+	+
Auto Gas Filling	+	+	+	+	+
Tilt Table for Unloading	✓	✓	✓	✓	✓
Can be upgraded to fully automatic sealing by adding sealing robot	+	+	+	+	+
Per unit speed with tilt	35 sec	35 sec	35 sec	35 sec	35 sec



# PANEL PRESS LINE FOR SUPER SPACER INSULATING TECHNOLOGY

Bassra Machine Tools Ltd.  
99 Spring Road, Tysley, Birmingham  
B11 3DJ, United Kingdom  
Tel :- +44-121-7074343, Fax :-+44-121-7073535  
Email :- [cjk@bassra.com](mailto:cjk@bassra.com), [sales@bassra.com](mailto:sales@bassra.com) , Website :- [www.bassra.com](http://www.bassra.com)





# BMT Automatic Super Spacer Panel Press Line



## Technical Data

The structure of the machine is very strong and robust

All parts touching water are made of non-corrosive material like SS, Plastic or Rubber. Motorized Inlet and Outlet Conveyor with both having black back panels

The motors for Brushes and Drive conveyor are outside and very easy to approach for any maintenance.

### • Inlet and Outlet unit :-

Automatic drives which pushes the glass in and pulls the glass out of the washer automatically.

Outlet Conveyor has inspection lights and a sensor at the end

### • Washing and drying unit :-

Machine is prepared to accept demineralized water/ RO Water.

Washing is done by Cylindrical brushes which works at High speed and spray the water uniformly.

Brushes are having big diameter and have inward adjustment on bearing housing which means after some wear and tear you can make the brushes go inwards and hence its life long lasting.

Brushes are very easy to replace which can be done by any operator without any help or guidance.

All Front Brushes are Soft Brushes and are capable to wash Low E Glass

Each pair of brushes have a separate water tank compartment with separate pump and filter.

Water Tanks are fitted with Heaters for Hot Water for better cleaning of glass.

Water tank fitted with float valve for controlling the water level it shows a light when the water level is low.

Water tanks are easy to detach, drain water and clean.

Drying is done by special air knives which are connected to high Pressure fan.

Fan sits inside a sound insulated Enclosure which meets the standards.

### Options :-

- Hot air drying facility for better and fast drying (OPTION)
- Brush Speed Control System
- Brushes moving backward with Pneumatic Cylinder to enable to wash Special Low E Glass.



#### • Super Spacer Tilting Table :-

Special table placed after washing machine having tilting, floatation and suction facility for easy application of super spacer bar. The second glass stops automatically on this part of the machine it comes to horizontal position. The operator uses the floatation and suction facility of this table to apply super spacer bar on the glass. Once operator has done its job then he can press the foot paddle, which brings the unit back to vertical position. Then the glass travels to Panel press via assembly unit. This automatic Panel Press line can be used both for super spacer bar (Flexible spacer bar) and aluminium spacer bar both.

#### • Assembly Rack :-

This unit is there for the use of aluminium spacer bar. The second Glass comes here and the spacer frame is applied here before it goes to panel press unit. Right angling unit enabling easy placement of the spacer profiles.

#### • Panel press :-

It is Fully Controlled by PLC for all its functions and sequence. The machine has touch screen system which displays all parts of line and its sensors which enables anyone to do fault finding. Display system shows operation of the line

in text format on one of the screen in the program.

Pressing function is done by Flat Panel. Suction pads inside the machine is used to pick the glass and place it in right position.

Alignment of two/three pieces of double or triple glass or step glass is done inside the press automatically.

Homogeneous Pressing is done automatically for the right time required according to the size of glass as this is already in the program of PLC recipe. The machine can work on manual mode also to enable it to press oversized glass sheets.

#### • Tilting table :-

Motorized rack which has tilting facility It has round wheels which is used for easy movement of glass unit in horizontal position to unload big pieces or to transport to sealing table or castor table for the next step which is secondary sealing.

#### Options :-

- Extra racks for enabling machine to increase the production capacity as more units will be waiting on those racks which one is already in press
- Step Glazing Function.



# BMT AUTOMATIC SUPER SPACER PANEL PRESS LINE

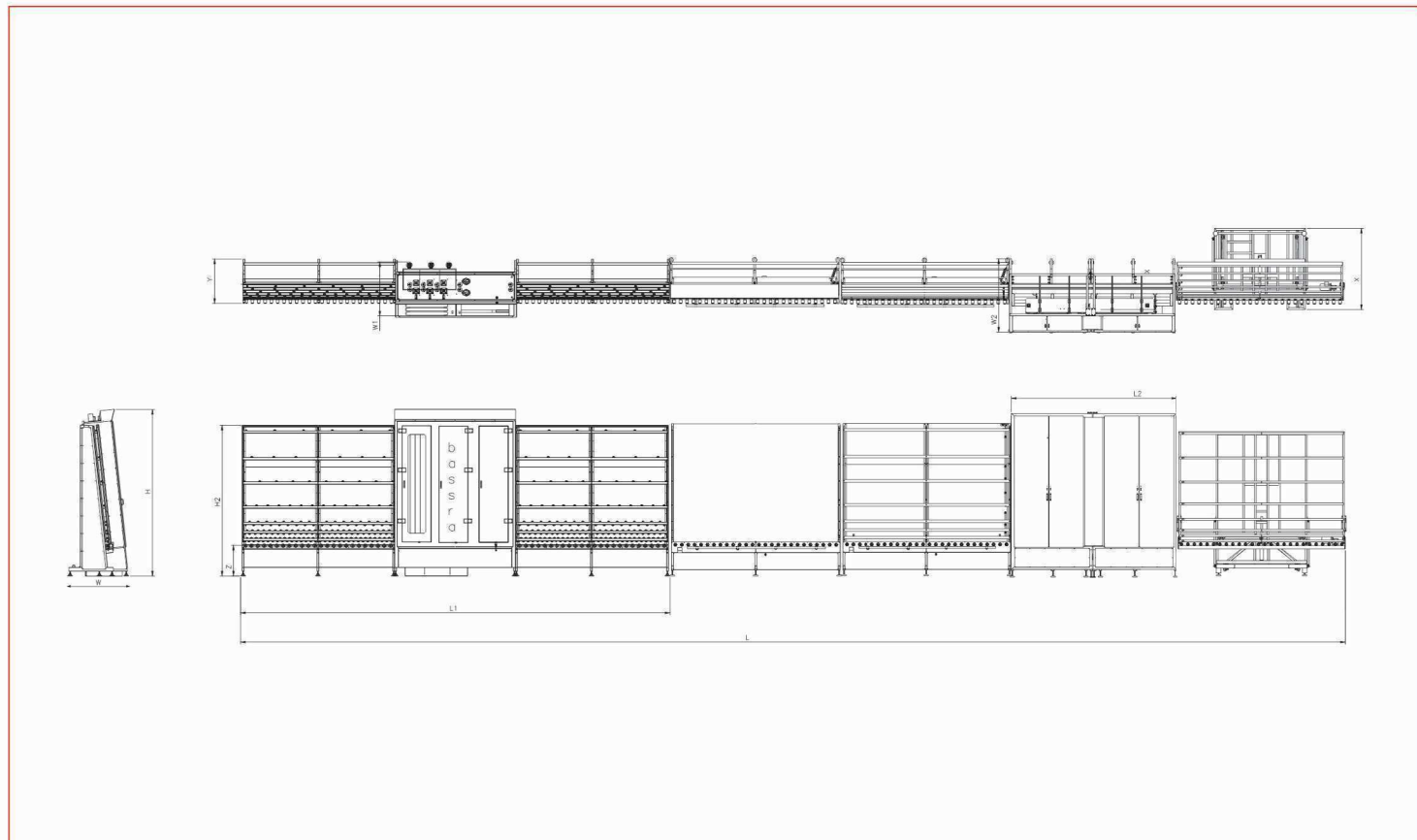

MACHINE MODELS		BMT-1.7-4-ASSPPL	BMT-1.7-6-ASSPPL	BMT-2.0-4-ASSPPL	BMT-2.0-6-ASSPPL	BMT-2.5-6-ASSPPL
OVERALL DIMENSIONS IN MM	L	20780	20780	20780	20780	21280
	W	2500	2500	2500	2500	3000
	H	2700	2700	3000	3000	3500
	L1	8150	8790	8150	8790	9070
	W1	930	930	930	930	930
	L2	2980	2980	2980	2980	3480
	W2	1540	1540	1540	1540	1540
	H2	2375	2375	2675	2675	3175
	X	1710	1710	1710	1710	1710
	Y	930	930	930	930	930
	Z	640	640	640	640	640
WEIGHT		5500 KG	5800 KG	5900 KG	6200 KG	6700 KG

All details mentioned on this brochure are subject to change at any time. Our standard term & condition apply.



Conveyers have Special Rollers made of Poly Urethane which has long life and very easy to change.  
 Conveyer Speed has a speed controller which is used to increase or decrease the speed.

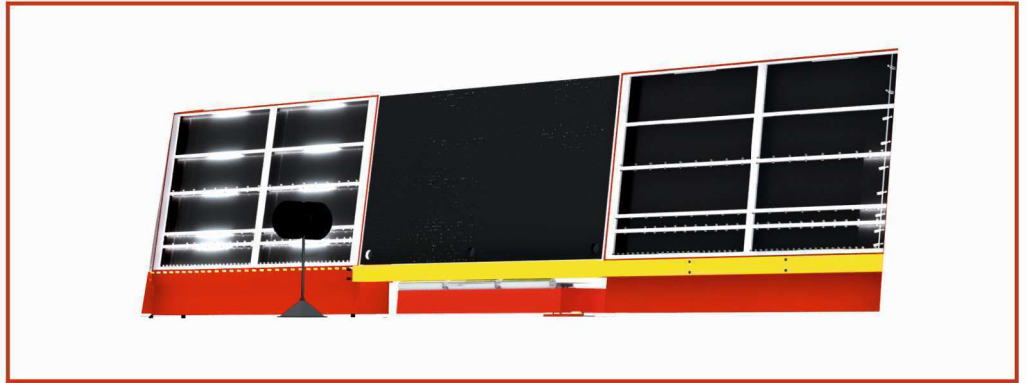

This panel press line is capable to work with warm edge spacer bar technology and aluminum or plastic spacerbar. To apply warm edge spacer tilt table is used and to apply aluminum spacer bar assembly table is used which is shown in the picture on the right side

✓ Standard   ✗ NA   + Option

	BMT-1.7-4-APPL	BMT-1.7-6-APPL	BMT-2.0-4-APPL	BMT-2.0-6-APPL	BMT-2.5-6-APPL
<b>OPERATING DATA</b>					
Max height of the Glass	2700mm x 1700mm	2700mm x 1700mm	2700mm x 2000mm	2700mm x 2000mm	3000mm x 2500mm
Min Glass Size	360mmX170mm	360mmX170mm	360mmX170mm	360mmX170mm	360mmX170mm
No. of Brushes	4	6	4	6	6
Open Top	✓	✓	✗	✗	✗
Speed of Washer	6m/min	6m/min	6m/min	6m/min	6m/min
Speed Control System on Conveyer	✓	✓	✓	✓	✓
Pre Rinse Section	✓	✓	✓	✓	✓
Brush Adjustment Backward for Special Soft Low E glass	+	+	+	+	+
Brushes with Speed Control system	+	+	+	+	+
Can Wash Low E Glass	✓	✓	✓	✓	✓
No. of Low E Brushes	2	3	2	3	3
No of Compartments in Water Tank	2	3	2	3	3
Hot Water Cleaning	✓	✓	✓	✓	✓
Sensors on all Racks	✓	✓	✓	✓	✓
Lights for Inspection	✓	✓	✓	✓	✓
Max.unit thickness	60 mm	60 mm	60 mm	60 mm	60 mm
Double and Triple Glass	✓	✓	✓	✓	✓
Step Glass	+	+	+	+	+
Auto Gas Filling	+	+	+	+	+
Tilt Table for Unloading	✓	✓	✓	✓	✓
Can be upgraded to fully automatic sealing by adding sealing robot	+	+	+	+	+
Per unit speed with tilt	35 sec	35 sec	35 sec	35 sec	35 sec





# AUTOMATIC SILICON SEALING ROBOT

INSULATING TECHNOLOGY

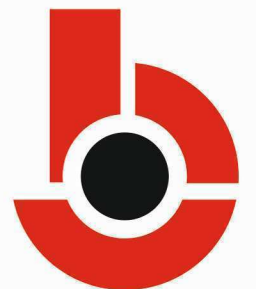

**bassra**  
machine tools ltd

# BMT AUTOMATIC SILICON SEALING ROBOT



Special design using V shape blocks on outlet conveyer system which has low wear and tear and very easy to clean. This also facilitates for finished unit to be unloaded by special fork system which can go under the glass unit in between these V blocks. This enables glass unit not to slip.

The outlet rack is divided in two parts which enables one piece of glass being sealed while other is waiting on the final outlet rack to be unloaded. This gives a better production capacity. Touch screen on the control panel..



Glass thickness is measured along with spacer bar gap at this point immediately after the unit comes out from the panel press line. The spacer bar thickness gives a signal to the sealing robot how much flow rate of silicon to be kept while sealing. This flow rate comes from the recipe which is stored in the PLC software.

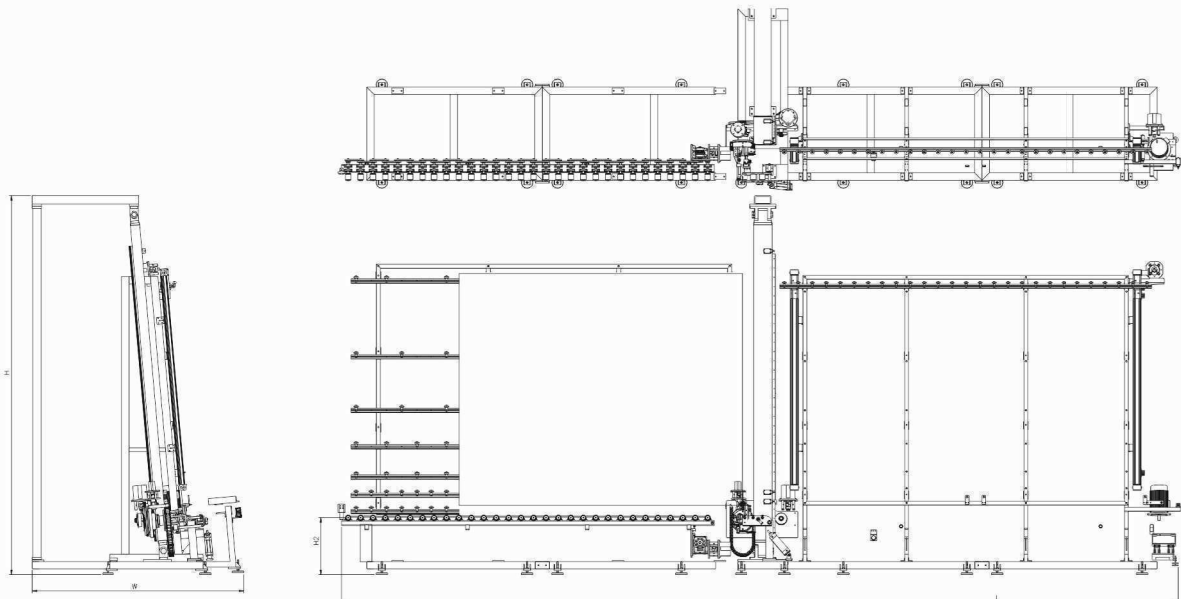



# Technical Data



MACHINE MODELS		BMT-1730-ASR	BMT-2030-ASR	BMT-2530-ASR	BMT-2535-ASR
OVERALL DIMENSIONS IN MM	L	8000	8000	8000	9000
	W	2280	2280	2280	2280
	H	3250	3550	4050	4050
	H1	600	600	600	600
WEIGHT		4500 kg	4800 kg	5000 kg	5500 kg
AIR PRESSURE		7 bar	7 bar	7 bar	7 bar
VOLTAGE		415 V 3NPE	415 V 3NPE	415 V 3NPE	415 V 3NPE
FREQUENCY		50 Hz / 60 Hz	50 Hz / 60 Hz	50 Hz / 60 Hz	50 Hz / 60 Hz

	BMT-1730-ASR	BMT-2030-ASR	BMT-2530-ASR	BMT-2535-ASR
<b>OPERATING DATA</b>				
Maximum Glass Size	1700 mm x 3000 mm	2000 mm x 3000 mm	2500 mm x 3000 mm	2500 mm x 3500 mm
Minimum Glass Size	350 mm x 200 mm	350 mm x 200 mm	350 mm x 200 mm	350 mm x 200 mm
Maximum Unit Thickness	12 mm to 60 mm	12 mm to 60 mm	12 mm to 60 mm	12 mm to 60 mm
Sealing Speed	30 m/min	30 m/min	30 m/min	30 m/min
Sealing Width	6 mm to 24 mm	6 mm to 24 mm	6 mm to 24 mm	6 mm to 24 mm
Sealing Depth	2 mm to 10 mm	2 mm to 10 mm	2 mm to 10 mm	2 mm to 10 mm
Step Glazing	+	+	+	+
Double Glazing	✓	✓	✓	✓
Triple Glazing	✓	✓	✓	✓
Thickness Sensor	✓	✓	✓	✓
Speed Control of Conveyor	✓	✓	✓	✓
Adjusting Mixing Ratio	✓	✓	✓	✓
Rinsing Facility	✓	✓	✓	✓



✓ Standard ✗ NA + Option

Innovative sealing technology and Modular engineering concept.

Continuous, automatic sealing of insulating glass units of different formats and dimensions

Fast, volume-controlled dosing system. Gear pump dosing technology ensures exact dosing. Homogeneously sealed corners due to nozzle system

Excellent mixing and dosing quality for all field-proven 1- or 2-component sealants for insulating glass  
Special conveyor systems for safe and clean transport.

Exact sealing all-around, even in case of irregular sealing depths, Automatic nozzle centering. No nozzle exchange for usual double insulating glass types.

Safe sealing of narrow air spaces by means of following guiding system for glass plates  
Adjustable mixing ratio.

Rinsing program for cleaning of mixing unit with base component. Rinsing cabinet for cleaning of the mixing unit and the nozzles with environmentally flushing detergents.  
Quick-action lock system for fast exchange of the nozzle and the mixing unit.

Automatic sealing of rectangular insulating glass units without prior data input.  
Sealing of double and triple insulating glass units possible

V-shaped, low wearout conveyor system in standard sealing robots for gentle glass transport  
Special conveyor system for stepped insulating glass units: Automatic adjustment of the conveyor system via data input for bottom edge (both glass plates supported) and spacer width (option).  
Take-off support for easy handling of insulating glass units

Options :-

- Alternative sealing of insulating glass units with different spacer profiles
- Quick-change system for processing a second type of sealant (e.g. Silicone)
- Extended run-out section for I.G. units up to 5 m long (16.404 feet) with support system for take-off of heavy insulating glass units





# HORIZONTAL WASHING

WASHING TECHNOLOGY

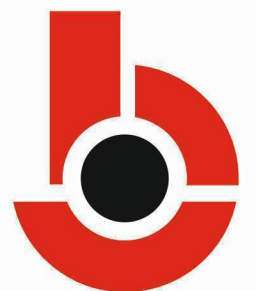
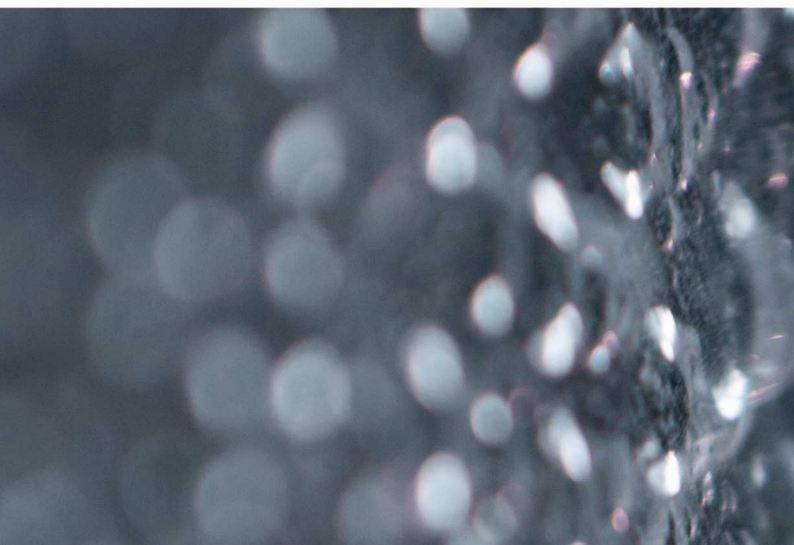

**bassra**  
machine tools ltd



# BMT HORIZONTAL GLASS WASHER

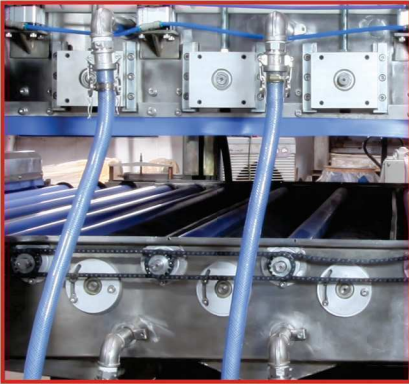

All top three brushes are soft brushes for Low E glass and bottom brushes are hard brushes..  
Top Brushes work on speed control system to control the speed for some special type of models.



We use 6 motors for six brushes to control each brush function individually which also helps controlling speed of top brushes for low e glass. ( available for some models only)

Washing and drying section can move upwards which gives enough space for operator to clean the machine inside.

Brushes have special bearing housing design by our team which has inward adjustment for brushes enhance you can use the brushes more time which means longer life of brushes.

Top brushes bearing housing have piston which enable them to go upwards when we select to use Low E glass. These all three brushes can go upwards individually or together which can be decided by the operator according to the sensitivity of the Low E glass which he wants to wash. ( This is available with some models only)

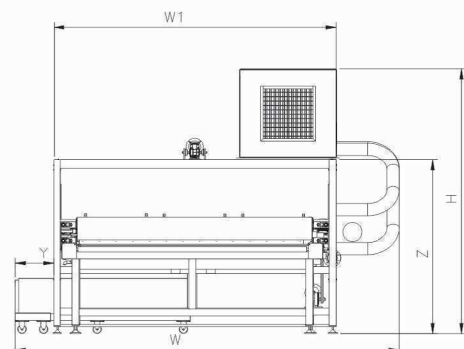
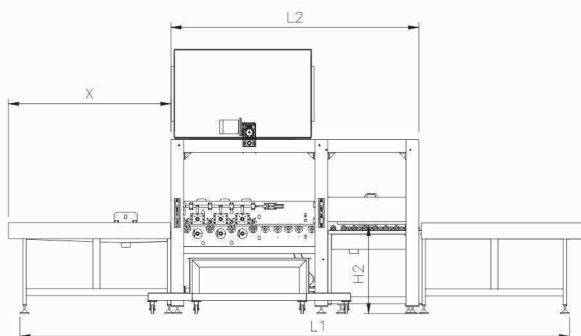
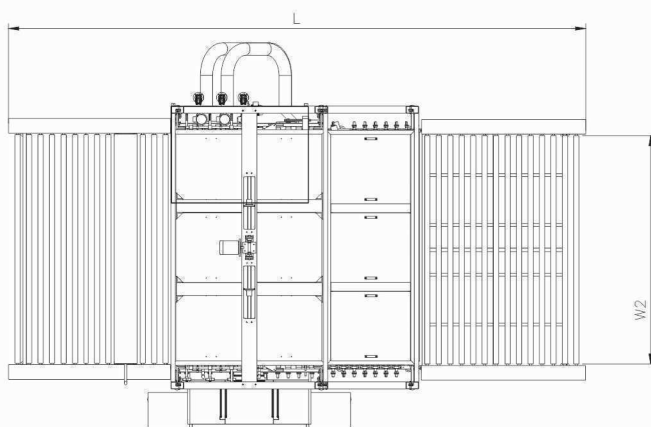

# Technical Data



MACHINE MODELS		BMT-2.5-6-HGW	BMT-2.5-6-HGW-SL	BMT-2.0-HGW	BMT-2.5-6-HGW-NL	BMT-2.0-6-HGW-NL
OVERALL DIMENSIONS IN MM	L	6575	6575	6475	6575	6475
	W	4380	4380	3830	4380	3830
	H	3000	3000	3000	3000	3000
	L1	6160	6160	6160	6160	6160
	W1	3215	3215	2715	3215	2715
	L2	2830	2830	2830	2830	2830
	W2	2600	2600	2100	2600	2100
	H2	1000	1000	1000	1000	1000
	X	1850	1850	1850	1850	1850
	Y	440	440	440	440	440
	Z	1980	1980	1980	1980	1980

	BMT-2.5-6-HGW	BMT-2.5-6-HGW-SL	BMT-2.0-HGW	BMT-2.5-6-HGW-NL	BMT-2.0-6-HGW-NL
<b>OPERATING DATA</b>					
Maximum Glass Width	2500mm	2500mm	2000mm	2500mm	2000mm
Min Glass Size	360mmX360mm	360mmX360mm	360mmX360mm	360mmX360mm	360mmX360mm
Maximum Glass Thickness	3 - 19 mm	3 - 19 mm	3 - 19 mm	3 - 19 mm	3 - 19 mm
Pre Wash section	✓	✓	✓	+	+
Air Knives and blower in Pre Wash section	✗	✓	✗	✗	✗
Number of Brushes	6	6	6	6	6
Top Brushes can move up while washing low e	✓	✓	✓	✗	✗
Brushes with Speed Control system	✗	✓	✗	✗	✗
Can Wash Low E Glass	YES	YES	YES	NO	NO
Voltage	380-415V	380-415V	380-415V	380-415V	380-415V
Hz	50 hz	50 hz	50 hz	50 hz	50 hz
Power	40 kw	40 kw	40 kw	28 kw	28 kw
Top Low E Brushes	✓	✓	✓	✗	✗
Sensor at Outlet Rack..	✓	✓	✓	✓	✓
Special High Pressure Blower	✓	✓	✓	+	+
Hot Water cleaning	✓	✓	✓	+	+
Lights on Unloading for inspection	✓	✓	✓	✓	✓
Motorized up and down	✓	✓	✓	✓	✓
Washing Section can go high for easy maintenance	✓	✓	✓	✓	✓

Other sizes apart of the above are also available onspacial request by the custmer

✓ Standard ✗ NA + Option

### Machines Feature :-

Robust Body with Powder Coat paint.Special motors with inverters for brushes and fan for Soft start hence no vibration on start. All moving parts are guarded for safety reasons. Lights on unloading table to inspect the glass. Unloading table has a sensor to stop the glass

### Loading and Unloading table :-

Loading table shafts are stainless steel to avoid rust. Loading table rollers are dipped in water for better cleaning of the glass.Stainless steel bearing for loading table wherever water touches due to pre wash section.Lights on unloading table to inspect the glass. Unloading table has a sensor to stop the glass automatically when it reaches the end.

### Washing Section :-

All fabrication parts inside this section are made of non-corrosive material. Special Stainless Steel bearings where applicable used to avoid any rusts. Special seals to avoid any water leakage. Water tank is stainless steel and water pipes are SS/hard Plastic/ Brass Water tanks are easy to drain the water and clean.Special water filters for better cleaning.

### Drying Section :-

This Section is use to dry the wet glass after washing. High performance Blowers.Perfect drying while running the machine with full speed with maximum size of glass.Two sets Air Knives are adjustable up, down and rotational wise. Fan section can be openedfor easy maintenance and can put on top of the machine or side of the machine if the roof of the factory is low. Special design of air knives to ensure maximum contact time of dry air with glass surface automatically when it reaches the end.

### Options :-

- Brushes with upward adjustment
- Pre Wash system and Pre wash with air knives and blower
- Brushes controlled with speed control system.





# VERTICAL WASHING

WASHING TECHNOLOGY

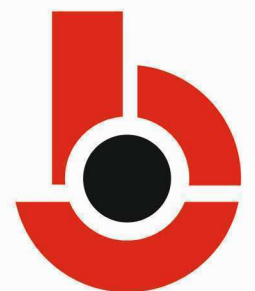

**bassra**  
machine tools ltd

# BMT VERTICAL WASHING MACHINE



Conveyers have Special Rollers made of Poly Urethane which has long life and very easy to change. Conveyor Speed has a speed controller which is used to increase or decrease the speed.

Motors are mounted outside the racks which are easily approachable and hence easy to service. Motors used are with gear box which controls the speed of the conveyer and helps increasing or decreasing the speed when ever necessary.

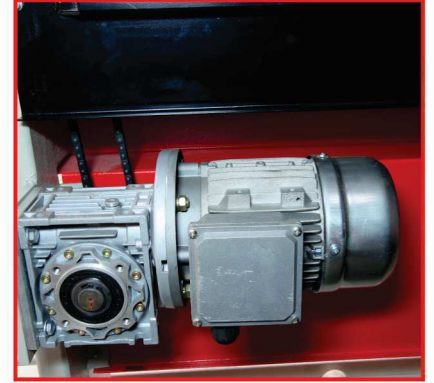

Brushes used are made of special Nylon. Low E brushes are of very good quality which has long life.

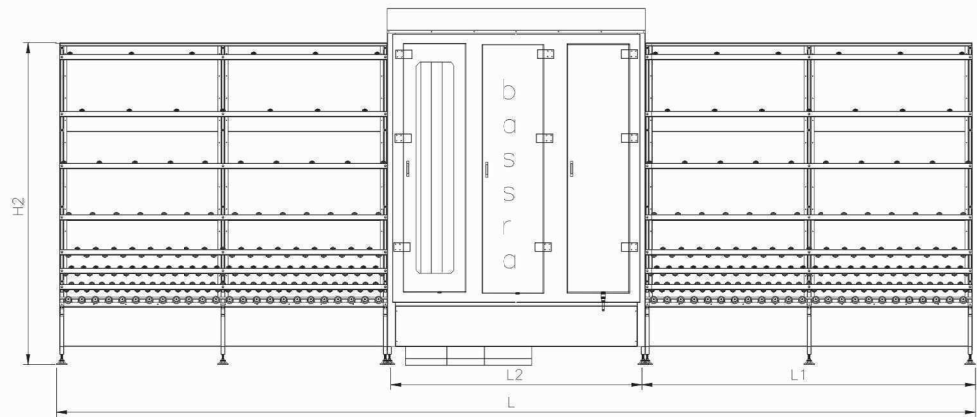
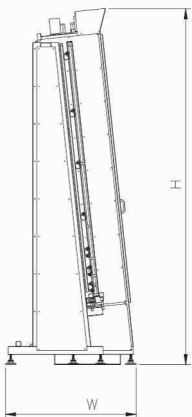
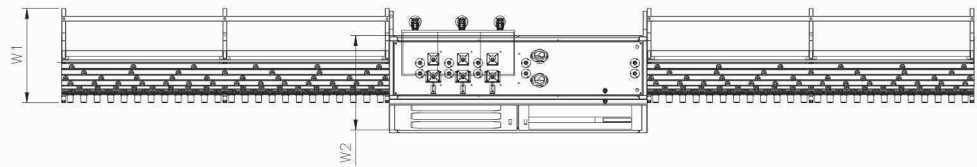



# Technical Data



MACHINE MODELS		BMT 1.7-4-VGW-O	BMT 1.7-6-VGW-O	BMT-2.0-4-VGW	BMT-2.0-6-VGW	BMT-2.5-6-VGW
OVERALL DIMENSIONS IN MM	L	8150	8790	8150	8790	9070
	W	2200	2200	2200	2200	2200
	H	2700	2700	3000	3000	3500
	L1	3000	3000	3000	3000	3290
	W1	930	930	930	930	930
	L2	1980	2480	1980	2480	2480
	W2	960	960	960	960	960
	H2	2375	2375	2675	2675	3175
WEIGHT		1900 kg	2100 kg	2100 kg	2300 kg	2900 kg

All details mentioned on this brochure are subject to change at any time. Our standard term & condition apply.

	BMT 1.7-4-VGW-O	BMT 1.7-6-VGW-O	BMT-2.0-4-VGW	BMT-2.0-6-VGW	BMT-2.5-6-VGW
<b>OPERATING DATA</b>					
Max height of the Glass	1700mm	1700mm	2000mm	2000mm	2500mm
Min Glass Size	360mmX170mm	360mmX170mm	360mmX170mm	360mmX170mm	360mmX170mm
No. of Brushes	4	6	4	6	6
Open Top	✓	✓	✗	✗	✗
Speed	6m/min	6m/min	6m/min	6m/min	6m/min
Speed Control System on conveyer	✓	✓	✓	✓	✓
Pre Rinse section	✓	✓	✓	✓	✓
Brush Adjustment Backward for special soft low e glass	+	+	+	+	+
Brushes with Speed Control system	+	+	+	+	+
Can Wash Low E Glass	✓	✓	✓	✓	✓
No. of Low E Brushes	2	3	2	3	3
No of Compartments in Water tank	2	3	2	3	3
Hot Water cleaning	✓	✓	✓	✓	✓
Sensor at Outlet Rack.	✓	✓	✓	✓	✓
Lights on Unloading for inspection	✓	✓	✓	✓	✓

✓ Standard ✗ NA + Option

The structure of the machine is very strong and robust

All parts touching water are made of non-corrosive material like SS, Plastic or Rubber. Motorized Inlet and Outlet Conveyer with both having black back panels

The motors for Brushes and Drive conveyer are outside and very easy to approach for any maintenance.

#### • Inlet and Outlet unit :-

Automatic drives which pushes the glass in and pulls the glass out of the washer automatically.

Outlet Conveyer has inspection lights and a sensor at the end to stop the glass when it comes to an end.

#### • Washing and drying unit :-

Machine is prepared to accept demineralized water/ RO Water.

Washing is done by Cylindrical brushes which works at High speed and spray the water uniformly.

Brushes are having a big diameter and have inward adjustment on bearing housing which means after some wear and tear you can make the brushes go inwards and hence its life long lasting.

Brushes are very easy to replace which can be done by any operator without our help or guidance.

All Front Brushes are Soft Brushes capable to wash Low E Glass

Each pair of brushes have a separate water tank compartment with separate pump and filter.

Water Tanks are fitted with Heaters for Hot water for better cleaning of glass. water tank fitted with float valve for

□controlling the water level and shows a light when the water level is low.

Water tanks are easy to detach, drain water and clean.

Drying is done by special air knives which are connected to high Pressure fan.

Fan sits inside a sound insulated Enclosure which meets the standards.

#### Options :-

- Hot air drying facility for better and fast drying (OPTION)
- Brushes moving backward with Pneumatic Cylinder to enable to wash Special Low E Glass.
- Brush Speed Control System





AUTOMATIC  
**CUTTING**  
LINES

**CUTTING TECHNOLOGY**



**bassra**  
machine tools ltd

# BMT AUTOMATIC CUTTING LINE

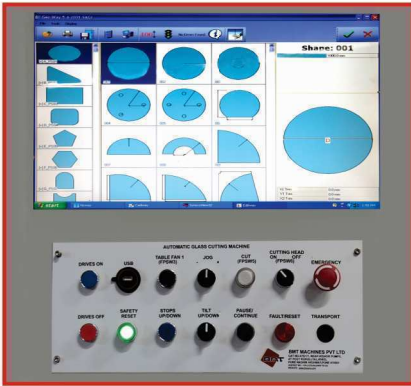

Automatic Cutting pressure adjustment when you choose glass thickness to cut. There is a recipe provided in the software, which chooses right cutting pressure for right thickness of glass automatically.

Special PC used with following features

- Data transfer via USB Key
- Wide screen
- Remote Access Control software for checking the machine remotely from our office.
- Fast Intel Processor with high capacity RAM and storage disk.
- Wireless internet facility to use Wifi in the factory.
- Anti Virus Software included.

Cutting wheel replacement is eased by the design of the machine and is carried out in a few seconds.

Movement transfer and measuring with gears (rack and pinion system) facing downwards which has advantage of impurities not depositing between teeth.

Axis controlled Servo Motors and drives are used in the machine for high speed and accuracy. Motors are Brushless.



Automatic Glass transfer from Loading Table to Cutting Table and then to Breaker bar table by transport belts.

Table is provided with automatic alignment stoppers which facilitates zero-zero alignment.

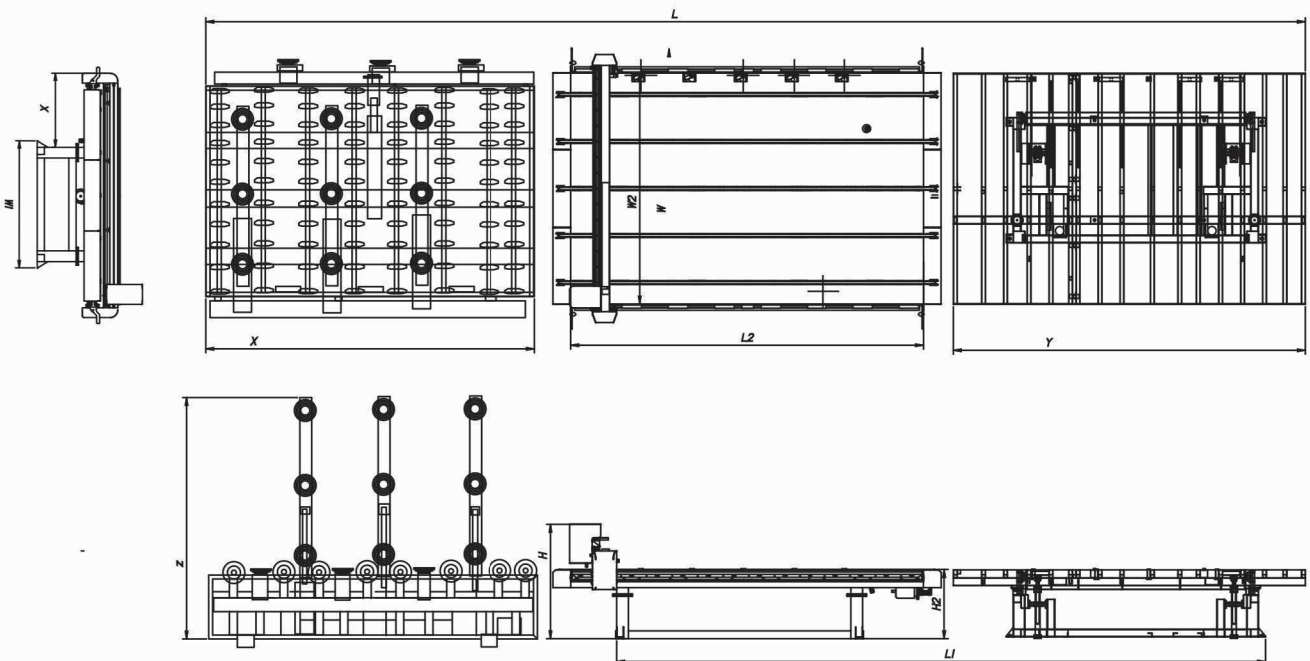



# Technical Data

Double Side Loading Station to load from racks at each side. Options available to have tracks to load two or three racks on each side.

Separate Breaker Bar Table attached have pneumatic controlled breaker bars with foot paddle at each side of the table to operate from any side.



MACHINE MODELS		BMT-3627-XY-L	BMT-3627-XYZ-L	BMT-4227-XY-L	BMT-4227-XYZ-L	BMT-6032-XY-L	BMT-6032-XYZ-L
OVERALL DIMENSIONS IN MM	L	14000	14000	16000	16000	21100	21100
	W	3575	3575	3575	3575	4050	4050
	H	1460	1460	1460	1460	1460	1460
	L1	8290	8290	9590	9590	12990	12990
	W1	1780	1780	1780	1780	2255	2255
	L2	4500	4500	5250	5250	6900	6900
	W2	2950	2950	2950	2950	3425	3425
	H2	885	885	885	885	885	885
	X	1035	1035	1035	1035	1035	1035
	Y	810	810	810	810	810	810
Z	2800	2800	2800	2800	3400	3400	
WEIGHT		7600 kg	7600 kg	9600 kg	9600 kg	14500 kg	14500 kg

All details mentioned on this brochure are subject to change at any time. Our standard term & condition apply.

	BMT-3627-XY-L	BMT-3627-XYZ-L	BMT-4227-XY-L	BMT-4227-XYZ-L	BMT-6032-XY-L	BMT-6032-XYZ-L
<b>OPERATING DATA</b>						
Maximum Glass Size	3660 mm x 2740 mm	3660mm x 2740 mm	4250mm x 2740 mm	4250mm x 2740 mm	6000mm x 3210 mm	6000mm x 3210 mm
Maximum Glass Thickness	3 - 19 mm	3 - 19 mm	3 - 19 mm	3 - 19 mm	3 - 19 mm	3 - 19 mm
Cutting Speed	130 m/min	130 m/min	130 m/min	130m/min	130 m/min	130 m/min
Cutting Tolerance	+/- 0.20 to 0.25 mm	+/- 0.20 to 0.25 mm	+/- 0.20 to 0.25 mm	+/- 0.20 to 0.25 mm	+/- 0.20 to 0.25 mm	+/- 0.20 to 0.25 mm
Air Pressure	7 bar	7 bar	7 bar	7 bar	7 bar	7 bar
Voltage	415 V 3NPE	415 V 3NPE	415 V 3NPE	415 V 3NPE	415 V 3NPE	415 V 3NPE
Frequency	50 Hz / 60 Hz	50 Hz / 60 Hz	50 Hz / 60 Hz	50 Hz / 60 Hz	50 Hz / 60 Hz	50 Hz / 60 Hz
Total power	25 KW	25 KW	30 KW	30 KW	40 KW	40 KW
Axis Control	Servo Controlled	Servo Controlled	Servo Controlled	Servo Controlled	Servo Controlled	Servo Controlled
Axis Movements	Rack and Pinion	Rack and Pinion	Rack and Pinion	Rack and Pinion	Rack and Pinion	Rack and Pinion
Optimization Software	OPTIMA	OPTIMA	OPTIMA	OPTIMA	OPTIMA	OPTIMA
Operating System	Microsoft Windows	Microsoft Windows	Microsoft Windows	Microsoft Windows	Microsoft Windows	Microsoft Windows
Data Transfer to Cutting Table	Network Cable or USB	Network Cable or USB	Network Cable or USB	Network Cable or USB	Network Cable or USB	Network Cable or USB
Shape Cutting	✘	✔	✘	✔	✘	✔
Automatic Cutting Pressure	✔	✔	✔	✔	✔	✔
Automatic Speed Adjustment	✔	✔	✔	✔	✔	✔
Automatic Alignment of Glass	+	+	+	+	+	+
Electronic Lubrication	✔	✔	✔	✔	✔	✔
Remote Access	✔	✔	✔	✔	✔	✔
Sensors for Safety ( Built in the machine)	✔	✔	✔	✔	✔	✔
Cutting Oil Tank	✔	✔	✔	✔	✔	✔
Blowers	✔	✔	✔	✔	✔	✔
Breaking Bars (X+Y) on Breaker Bar Table	✔	✔	✔	✔	✔	✔

✔ Standard ✘ NA + Option

Very Robust Structure made up of thick and heavy Metal, protected by Powder coating Paint (chemical cleaning, primer and powder coating), for good finish and rust-prevention for many years.

Accurately flat and carpet padded wooden table surface. The wooden board used is special thick board made to order for this machine. This gives a long life and smooth straight surface to the table for good cutting quality.

Power full air cushion on breaker bar table for better flotation of bigger and heavy sheets. This will reduce friction and enables easy handling of glass.

The Operator is trained in very easy way so that he can remember all instructions. Retraining programs can also be done online with remote access feature of the machine.

Safety Sensors on all 4 side of cutting table to avoid any accidents if any worker just enters the area when machine is working then machine stops automatically.

Electrical system compliant with general safety rules

OPTIMA Optimiser Programme is available with the machine in various options of languages and features.

Software is Microsoft Window Based System so that any operator can understand very easily.

The Software on the machine have many controls as mentioned below. This enables to check all controls individually while servicing the machine.

- Cutting pressure
- Acceleration and Deceleration,
- Speed
- Oil start and stop
- Head movement
- Head up and down
- Simulation Mode
- Blower On/Off
- Automatic Mode/ Manual Mode
- Belts Transfer

Options :-

- Laser scanner system for odd shapes
- Low-E Edge Deletion system for straight and shape glass
- Double zero for cutting of Laminated glass
- Vinyl Cutting





# CUTTING TABLE WITH BELT

CUTTING TECHNOLOGY



**bassra**  
machine tools ltd

# BMT AUTOMATIC CUTTING TABLE (WITH BELTS)

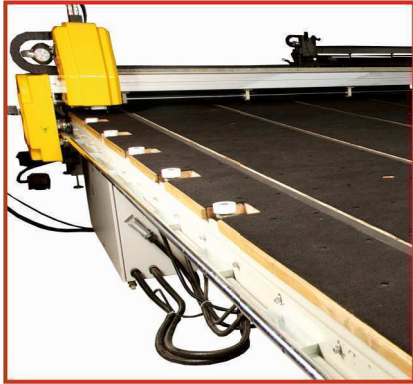

This type of Cutting Table has transport belts system. This type of table can be converted into automatic cutting line by adding automatic loader and breaker bar table. It can also be converted to half line by adding breaker bar table.

Cutting wheel replacement is eased by the shape design of the machine and is carried out in a few seconds.

Movement transfer and measuring with gears (rack and pinion system) facing downwards which has advantage of impurities not depositing between teeth.

Axis controlled Servo Motors and drives are used in the machine for high speed and accuracy. Motors are Brushless.

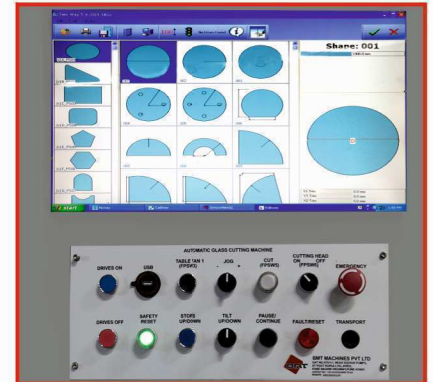

Automatic Cutting pressure adjustment when you choose glass thickness to cut. There is a recipe provided in the software, which chooses right cutting pressure for right thickness of glass automatically.

Special PC used with following features

- Data transfer via USB Key
- Wide screen
- Remote Access Control software for checking the machine remotely from our office.
- Fast Intel Processor with high capacity RAM and storage disk.
- Wireless internet facility to use Wifi in the factory.

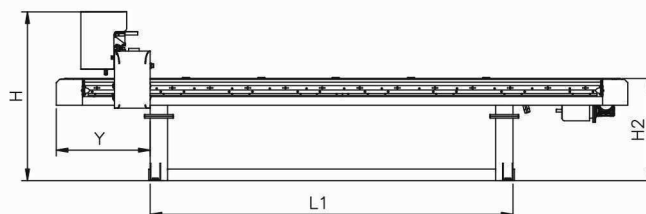
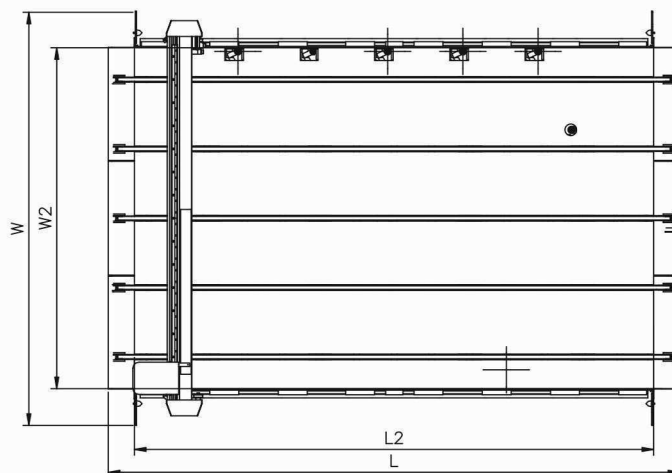
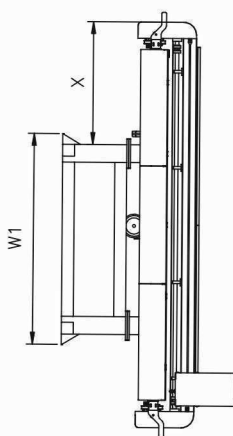



# Technical Data



MACHINE MODELS		BMT-3627-XY-B	BMT-3627-XYZ-B	BMT-4227-XY-B	BMT-4227-XYZ-B	BMT-6032-XY-B	BMT-6032-XYZ-B
OVERALL DIMENSIONS IN MM	L	4950	4950	5600	5600	7300	7300
	W	3575	3575	3575	3575	4050	4050
	H	1460	1460	1460	1460	1460	1460
	L1	3140	3140	3790	3790	5490	5490
	W1	1780	1780	1780	1780	2255	2255
	L2	4500	4500	5150	5150	6850	6850
	W2	2950	2950	2950	2950	3425	3425
	H2	885	885	885	885	885	885
	X	1035	1035	1035	1035	1035	1035
	Y	810	810	810	810	810	810
WEIGHT		2700 KG	2700 KG	3200 KG	3200 KG	5500 KG	5500 KG

	BMT-3627-XY-B	BMT-3627-XYZ-B	BMT-4227-XY-B	BMT-4227-XYZ-B	BMT-6032-XY-B	BMT-6032-XYZ-B
<b>OPERATING DATA</b>						
Maximum Glass Size	3660 x 2740 mm	3660 x 2740 mm	4250 x 2740 mm	4250 x 2740 mm	6000 x 3210 mm	6000 x 3210 mm
Maximum Glass Thickness	3 - 19 mm	3 - 19 mm	3 - 19 mm	3 - 19 mm	3 - 19 mm	3 - 19 mm
Cutting Speed	130 m/min	130 m/min	130 m/min	130 m/min	130m/min	m/min
Cutting Tolerance	+/- 0.20 mm to 0.25 mm	+/- 0.20 mm to 0.25 mm	+/- 0.20 mm to 0.25 mm	+/- 0.20 mm to 0.25 mm	+/- 0.20 mm to 0.25 mm	+/- 0.20 mm to 0.25 mm
Air Pressure	7 bar	7 bar	7 bar	7 bar	7 bar	7 bar
Voltage	400 V 3NPE	400 V 3NPE	400 V 3NPE	400 V 3NPE	400 V 3NPE	400 V 3NPE
Frequency	50 Hz / 60 Hz	50 Hz / 60 Hz	50 Hz / 60 Hz	50 Hz / 60 Hz	50 Hz / 60 Hz	50 Hz / 60 Hz
Total power(with air cushion option)	12 KW	12 KW	15 KW	15 KW	18 KW	18 KW
Axis Control	Servo Controlled	Servo Controlled	Servo Controlled	Servo Controlled	Servo Controlled	Servo Controlled
Axis Movements	Rack and Pinion	Rack and Pinion	Rack and Pinion	Rack and Pinion	Rack and Pinion	Rack and Pinion
Optimization Software	OPTIMA	OPTIMA	OPTIMA	OPTIMA	OPTIMA	OPTIMA
Operating System	Microsoft Windows	Microsoft Windows	Microsoft Windows	Microsoft Windows	Microsoft Windows	Microsoft Windows
Data Transfer to Cutting Table	Network Cable or USB	Network Cable or USB	Network Cable or USB	Network Cable or USB	Network Cable or USB	Network Cable or USB
Shape Cutting	✘	✔	✘	✔	✘	✔
Automatic Cutting Pressure	✔	✔	✔	✔	✔	✔
Automatic Speed Adjustment	✔	✔	✔	✔	✔	✔
Automatic Alignment of Glass	+	+	+	+	+	+
Electronic Lubrication	✔	✔	✔	✔	✔	✔
Remote Access	✔	✔	✔	✔	✔	✔
Sensors for Safety ( Built in the machine)	✔	✔	✔	✔	✔	✔
Cutting Oil Tank	✔	✔	✔	✔	✔	✔
Blowers	✔	✔	✔	✔	✔	✔

✔ Standard ✘ NA + Option

Very Robust Structure made up of thick and heavy metal, protected by Powder coating Paint (chemical cleaning, primer and powder coating), for good finish and rust-prevention for many years.

Accurately flat and carpet padded wooden table surface. The wooden board used is special thick board made to order for this machine. This gives a long life and smooth straight surface to the table for good cutting quality.

The Operator is trained in very easy way so that he can remember all instructions. Re-training programs can also be done online with remote access feature of the machine.

Safety Sensors on all 4 side of cutting table to avoid any accidents if any worker just enters the area when machine is working then machine stops automatically.

Electrical system compliant with general safety rules

OPTIMA Optimiser Programme is available with the machine in various options of languages and features.

Software is Microsoft Window Based System so that any operator can understand very easily.

The Software on the machine have many controls as mentioned below. This enables to check all controls individually while servicing the machine.

- Cutting pressure
- Acceleration and Deceleration,
- Speed
- Oil start and stop
- Head movement
- Head up and down
- Simulation Mode
- Blower On/Off
- Automatic Mode/ Manual Mode
- Belts Transfer

Options :-

- Laser scanner system for odd shapes
- Low-E Edge Deletion system for straight and shape glass
- Can be upgraded to Automatic Cutting Line
- Double zero for cutting of Laminated glass
- Vinyl Cutting
- Air Cushion





# CUTTING TABLE WITH BREAKER BARS

CUTTING TECHNOLOGY

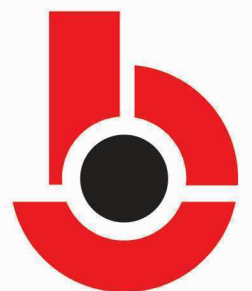

**bassra**  
machine tools ltd

# BMT AUTOMATIC CUTTING TABLE (WITH BREAKER BARS)



Pneumatic controlled breaker bars with foot paddle at each side to operate from any side.

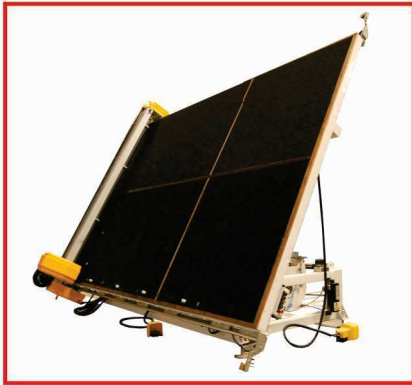

Tilting facility available as option

Cutting wheel replacement is eased by the design of the machine and is carried out in a few seconds.

Movement transfer and measuring with gears (rack and pinion system) facing downwards which has advantage of impurities not depositing between teeth.

Axis controlled Servo Motors and drives are used in the machine for high speed and accuracy. Motors are Brushless.

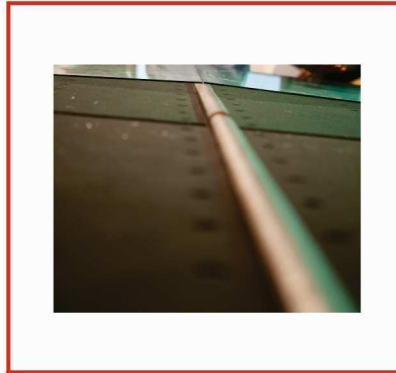

Automatic Cutting pressure adjustment when you choose glass thickness to cut. There is a recipe provided in the software, which chooses right cutting pressure for right thickness of glass automatically

Special PC used with following features

- Data transfer via USB Key
- Wide screen
- Remote Access Control software for checking the machine remotely from our office.
- Fast Intel Processor with high capacity RAM and storage disk.
- Wireless internet facility to use Wifi in the factory.

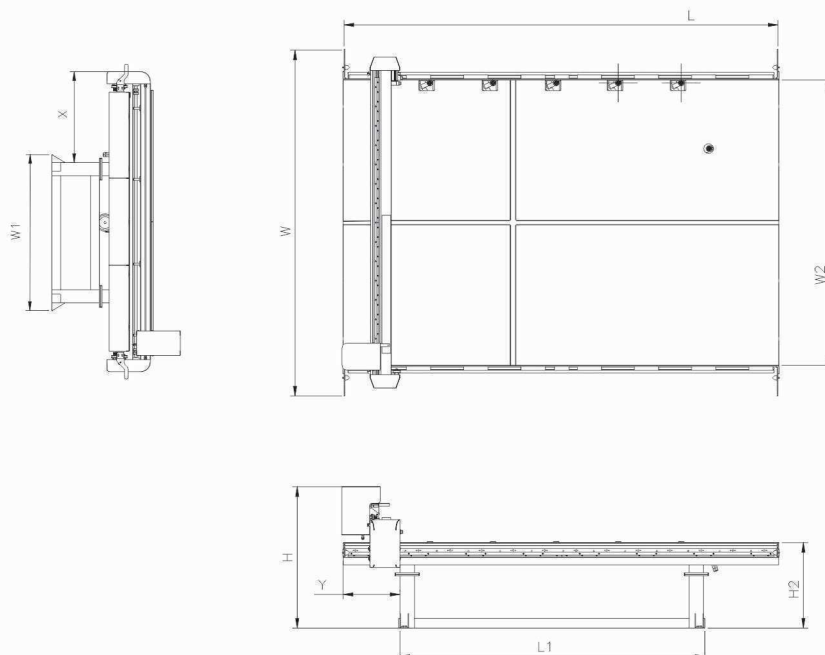



# Technical Data

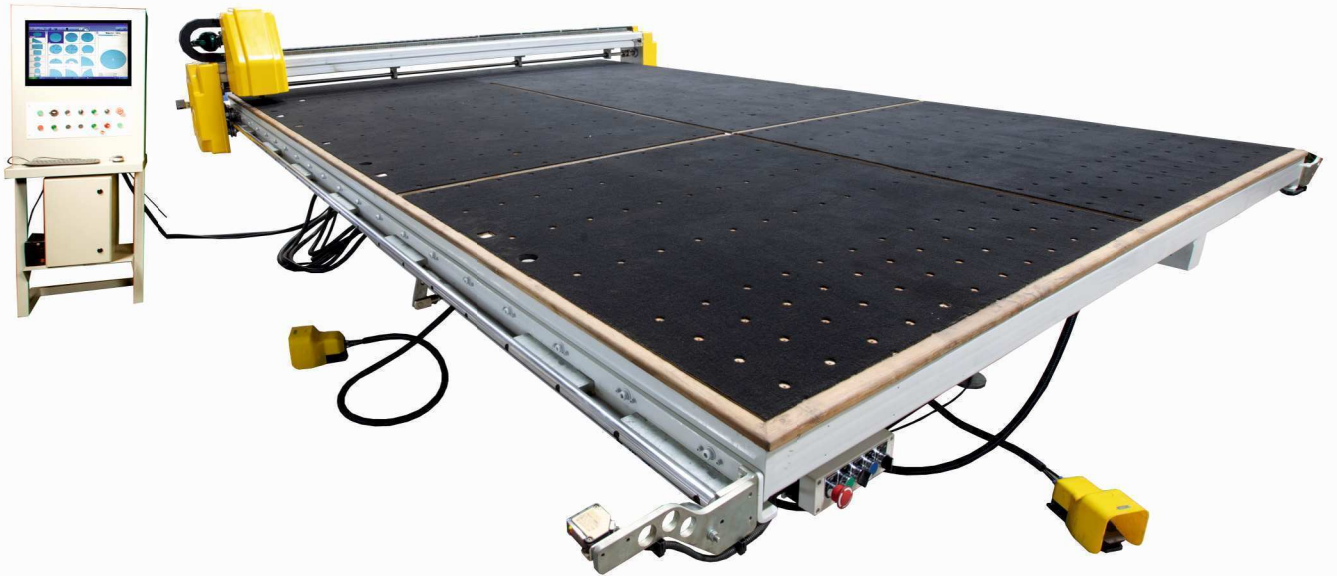

MACHINE MODELS		BMT-3627-XY	BMT-3627-XYZ	BMT-4227-XY	BMT-4227-XYZ	BMT-6032-XY	BMT-6032-XYZ
OVERALL DIMENSIONS IN MM	L	4500	4500	5250	5250	6900	6900
	W	3575	3575	3575	3575	4050	4050
	H	1460	1460	1460	1460	1460	1460
	L1	3140	3140	3790	3790	5490	5490
	W1	1780	1780	1780	1780	2255	2255
	W2	2950	2950	2950	2950	3425	3425
	H2	885	885	885	885	885	885
	X	1035	1035	1035	1035	1035	1035
	Y	580	580	580	580	580	580
WEIGHT		2700 KG	2700 KG	3200 KG	3200 KG	5500 KG	5500 KG

	BMT-3627-XY	BMT-3627-XYZ	BMT-4227-XY	BMT-4227-XYZ	BMT-6032-XY	BMT-6032-XYZ
<b>OPERATING DATA</b>						
Maximum Glass Size	3660 x 2740 mm	3660 x 2740 mm	4250 x 2740 mm	4250 x 2740 mm	6000 x 3210 mm	6000 x 3210 mm
Maximum Glass Thickness	3 - 19 mm	3 - 19 mm	3 - 19 mm	3 - 19 mm	3 - 19 mm	3 - 19 mm
Cutting Speed	130 m/min	130 m/min	130 m/min	130 m/min	130 m/min	130 m/min
Cutting Tolerance	+/- 0.20 mm to 0.25 mm	+/- 0.20 mm to 0.25 mm	+/- 0.20 mm to 0.25 mm	+/- 0.20 mm to 0.25 mm	+/- 0.20 mm to 0.25 mm	+/- 0.20 mm to 0.25 mm
Air Pressure	7 bar	7 bar	7 bar	7 bar	7 bar	7 bar
Voltage	400 V 3NPE	400 V 3NPE	400 V 3NPE	400 V 3NPE	400 V 3NPE	400 V 3NPE
Frequency	50 Hz / 60 Hz	50 Hz / 60 Hz	50 Hz / 60 Hz	50 Hz / 60 Hz	50 Hz / 60 Hz	50 Hz / 60 Hz
Total power(with air cushion option)	12 KW	12 KW	15 KW	15 KW	18 KW	18 KW
Axis Control	Servo Controlled	Servo Controlled	Servo Controlled	Servo Controlled	Servo Controlled	Servo Controlled
Axis Movements	Rack and Pinion	Rack and Pinion	Rack and Pinion	Rack and Pinion	Rack and Pinion	Rack and Pinion
Optimization Software	OPTIMA	OPTIMA	OPTIMA	OPTIMA	OPTIMA	OPTIMA
Operating System	Microsoft Windows	Microsoft Windows	Microsoft Windows	Microsoft Windows	Microsoft Windows	Microsoft Windows
Data Transfer to Cutting Table	Network Cable or USB	Network Cable or USB	Network Cable or USB	Network Cable or USB	Network Cable or USB	Network Cable or USB
Shape Cutting	✘	✔	✘	✔	✘	✔
Automatic Cutting Pressure	✔	✔	✔	✔	✔	✔
Automatic Speed Adjustment	✔	✔	✔	✔	✔	✔
Automatic Alignment of Glass	+	+	+	+	+	+
Electronic Lubrication	✔	✔	✔	✔	✔	✔
Remote Access	✔	✔	✔	✔	✔	✔
Sensors for Safety ( Built in the machine)	✔	✔	✔	✔	✔	✔
Cutting Oil Tank	✔	✔	✔	✔	✔	✔
Blowers	✔	✔	✔	✔	✔	✔
Breaking Bars (X+Y) on Breaker Bar Table	✔	✔	✔	✔	✔	✔

✔ Standard ✘ NA + Option

Very Robust Structure made up of thick and heavy metal, protected by Powder coating Paint (chemical cleaning, primer and powder coating), for good finish and rust-prevention for many years.

Accurately flat and carpet padded wooden table surface. The wooden board used is special thick board made to order for this machine. This gives a long life and smooth straight surface to the table for good cutting quality.

Power full air cushion for better flotation of bigger and heavy sheets. This will reduce friction and enables easy handling of glass.

The Operator is trained in very easy way so that he can remember all instructions. Retraining programs can also be done online with remote access feature of the machine.

Safety Sensors on all 4 side of cutting table to avoid any accidents if any worker just enters the area when machine is working then machine stops automatically.

Electrical system compliant with general safety rules

OPTIMA Optimiser Programme is available with the machine in various options of languages and features.

Software is Microsoft Window Based System so that any operator can understand very easily.

The Software on the machine have many controls as mentioned below. This enables to check all controls individually while servicing the machine.

- Cutting pressure
- Acceleration and Deceleration,
- Speed
- Oil start and stop
- Head up and down
- Simulation Mode
- Blower On/Off
- Automatic Mode/ Manual Mode
- Head movement

#### Options :-

- Laser scanner system for odd shapes
- Low-E Edge Deletion system for straight and shape glass
- Tilting Facility
- Double zero for cutting of Laminated glass
- Vinyl Cutting

All details mentioned on this brochure are subject to change at any time. Our standard term & condition apply.





# ALLIED MACHINES

INSULATING TECHNOLOGY

Bassra Machine Tools Ltd.  
99 Spring Road, Tysley, Birmingham  
B11 3DJ, United Kingdom  
Tel :- +44-121-7074343, Fax :-+44-121-7073535  
Email :- [cjk@bassra.com](mailto:cjk@bassra.com), [sales@bassra.com](mailto:sales@bassra.com), Website :- [www.bassra.com](http://www.bassra.com)



**bassra**  
machine tools ltd

# BMT Silicon Extruder ( BMT-SE )



- Rigid steel body with powder coating.
- Special body design for 200 and 20 ltr barrels.
- Adjustable mixing ratio between 1/5 and 1/15 by dosage pump.
- Hydraulic driven A component and dosage pump.
- Thermostat controlled heater for A component plate.
- Special design of A component plate for low loss of material.
- Dehumidifier unit for B component in polyurethane extruder.
- High pressure resistant holes.
- Relay controlled electronic system.
- Warning for over pressure.
- Special sealing system in dosage pump for less maintenance.
- By-pass system for preventing the freeze of material in stand- by mode.
- Polyurethane, Silicon, Thiokol (poly-sulfide) materials can be used in same machine.
- Change of work material from Silicon or Thiokol to polyurethane in three hours.
- Air driven B component catalyst pump.
- Material filter for B component.
- Auto-stop system against unexpected pressure changes.

## Machine Features

## Technical Data

• Mixing ratio range	-	1/5 to 1/15
• Voltage	-	400 V 3 NPE AC
• Frequency	-	50 Hz
• Total power	-	3,6 kW
• Air pressure	-	6 Bar
• Air consumption	-	250 l/min
• Length	-	1500 mm
• Width	-	920 mm
• Height	-	2550 mm
• Weight	-	450 kg

# BMT Butyl Extruder ( BMT-7BE )

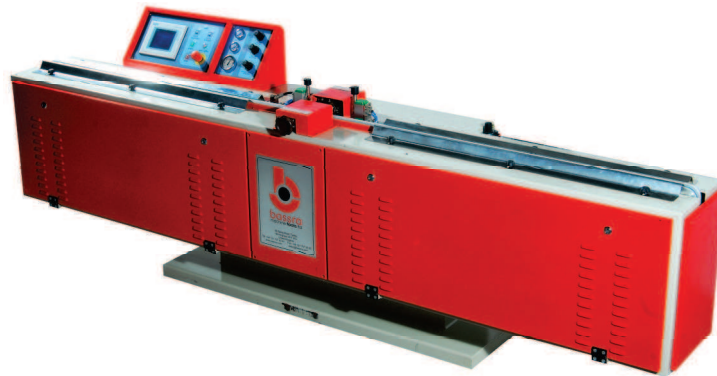

## Machine Features

- Powder coated paint on rigid steel body
- Machine capacity is 7 kg cylindrical blocks
- Height and width adjustable butyl nozzles
- Adjustable material flow rate
- Exact temperature control system
- Air driven hydraulic unit electric motor(option)
- Pressure safety system to check high or low pressures.
- Temperature control system to prevent operating below 110°C
- Individual temperature measuring of butyl cylinder and nozzles
- Two clamps over the conveyor direction for straight butyl injection
- 57 m/min belt speed (with rectangular shaped spacer bars)
- 80 m/min belt speed (with straight spacer bars)
- Electrical system compliant with general safety rules
- Isolated butyl cylinder
- Warm up time 20 minutes only
- Adjustable working pressure
- Timer system for switching on/off

## Technical Data

• Process able profile thickness range	-	6-24 mm
• Tank capacity	-	7kg
• Voltage	-	400 V 3 NPE AC
• Frequency	-	50 Hz
• Total power	-	5.5 kW
• Air pressure	-	6 Bar
• Air consumption	-	10 l/min
• Length	-	3000 mm
• Width	-	700 mm
• Height	-	1050 mm
• Weight	-	500 kg



# BMT Hot Melt Extruders



✓ Standard + Option ✗ NA

## Machine Features

- Digital readout of all temperature zones.
- Under temperature on all zones.
- Programmable temperature controls which can be programmed to any make of Hot melt blocks.
- Positive displacement gear type pump.
- Progressive sealant heating hopper, pump hose and gun.
- Tamper proof factory set operating temperatures.
- 'Cool to touch' moulded gun handle.
- Miniature circuit breaker protection.

## Technical Data

	BMT1000	BMT 2000	BMT 3000	BMT 4000
Production Capacity Approx.	80-100 Units in 8-10 hrs	160-200 Unit in 8-10 hrs	250-300 units in 8-10 hrs	350-400 units in 8-10 hrs
Material Output	1kg/min	2kg/min	3kg/min	4kg/min
Hopper Size	30kg	50 Kg	75Kg	125kg
Temperature controller	3	4	4	4
Programmable 7 Days timer	+	✓	✓	✓
Hose Length	3m	3m	3m	3m
Length	720mm	880mm	1020mm	1120mm
Width	420mm	570mm	570mm	750mm
Height	970mm	1240mm	1370mm	1650mm
Weight	150 kg	250 kg	400 kg	450 kg
Voltage	220V/240	V220V/240V	220V/240V	220V/240V
Frequency	50/60Hz	50/60Hz	50/60Hz	50/60Hz
Power	2.2Kw/10 Amps	3 kw/13Amps	3.5Kw/15 Amps	4.8kw/20Amps

# BMT Press Table / Clamp Table



✓ Standard + Option ✗ NA

## Machine Features

- Clamping action is controlled by a conveniently situated foot pedal.
- Fully adjustable rise and fall speed.
- Unique design allows any length of glass to be sealed efficiently.
- Hard wearing swivel castors allow maximum rotation with minimum effort.
- Clamping Gap: Up to 42mm (cushioned by heavy industrial rubber).
- Fully adjustable jaw pressure.
- Open Ended Jaw.
- Multi-Directional Rollers.
- Air operated.

## Technical Data

Note :- Any non-standard sizes can be manufactured to suit customers requirements.

	BMT-PT-1010	BMT-PT-1515	BMT-PT-2015	BMT-PT-3020
Glass Size	1000mmX 1000mm	1500mmX1500mm	2000mmX1500mm	3000mmX 2000mm
Length	1050mm	1550mm	1550mm	2050mm
Width	1050mm	1550mm	2050mm	3050mm
Height	900-950mm	900-950mm	900-950mm	900-950mm
Weight	80kg	120kg	150kg	250kg
Air Pressure	6 Bar	6 Bar	6 Bar	6 Bar
Foot Pedal	✓	✓	✓	✓

# BMT Digital Profile Cutting Machine



## Machine Features

- Profile cutting length: 80mm - 2800mm.
- Digital measurement indicator.
- Cutting without burr.
- Cutting more than one simultaneously.
- Adjustable tolerance ratio cutting.

## Technical Data

- Voltage - 415V
- Frequency - 50Hz
- Total power - 1.1 kW
- Air pressure - 6 bar
- Air consumption- 0.3lt/min
- Length - 6525mm
- Width - 500mm
- Height - 1245mm
- Weight - 200kg

# BMT Free Standing Desiccant Dispenser



## Machine Features

- Tank volume :25kg.
- Heating system to provide constant heat inside the tank .
- Vibration System for material filling.
- Collection unit to prevent any waste material.
- Pneumatic vibration filling system.

## Technical Data

- Voltage - 220/240v
- Frequency - 50 Hz
- Total Power - 0.5w
- Air Pressure - 6 bar
- Air consumption - 16.8 lt /min
- Length - 2450mm
- Width - 385mm
- Height - 1700mm
- Weight - 80kg



# BMT Air Floatation Table ( BMT-AFT )



## Machine Features

- Robust Rubber Surface.
- Suck and Blow Table.
- Electronic Foot pedal Operated.
- Ideal for application of Super Spacer.
- Modifications available at your requirement.
- Min Glass Size:150 x 150.
- Single or 3phase versions available.

## Technical Data

- Voltage - 415V
- Frequency - 50Hz
- Total power - 3 kW
- Air pressure - 6 bar
- Length - 2150mm
- Width - 1250mm
- Height - 900-950mm
- Weight - 300kg

# BMT Rotating Table ( BMT-RT )

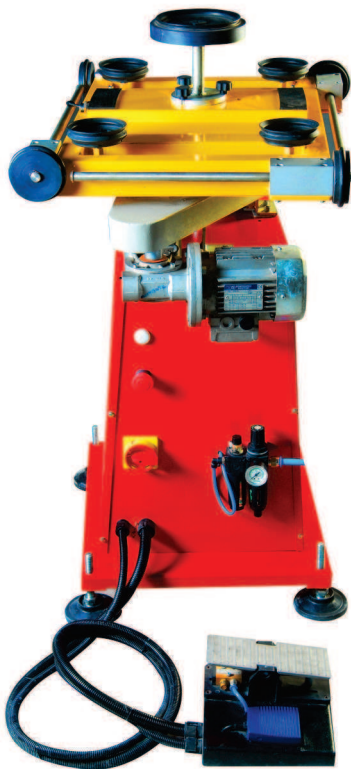

## Machine Features

- Single suction cup for smaller peices of glass
- Four smaller suction cups and telescopic arms for larger peices of glass.
- 0° - 360° rotation.
- Foot operated pedals with pneumatic suction and locking Technical Data facility

## Technical Data

- Voltage - 415V
- Frequency - 50Hz
- Total power - 0.25 KW
- Air pressure - 6 bar
- Air consumption - 0.3lt/min
- Length - 710mm
- Width - 450mm
- Height - 1120mm
- Weight - 100kg

# BMT Freezer ( BMT-F )



## Machine Features

- It has two section one for freezer and one for heating.
- Overflow of liquid is prevented while working.
- Digital display system fitted.
- Alarm system is fitted.
- Machine is light in weight and comes on wheels.
- R 404 gas is required for the compressor.

## Technical Data

- Width - 700 mm
- Length - 700 mm
- Height - 1000 mm
- Weight - 80kg
- Voltage - 240 V/415V
- Frequency - 50 Hz
- Power - 3 kw
- Air Pressure - 6 bar

# BMT Gas Filler ( BMT GF-8 )



## Machine Features

- Can be used for Argon or SF6 Gas.
- Automatic indication to notify gas has been filled in unit.
- Flow Capacity of gas can be adjusted with regulator.
- Very compact machine so less space is required.

## Technical Data

- Width - 355 mm
- Length - 400 mm
- Height - 140 mm
- Weight - 4kg
- Voltage - 240 V
- Frequency - 50 Hz
- Power - 30 VA
- Air Pressure - 3 bar 10NL/min



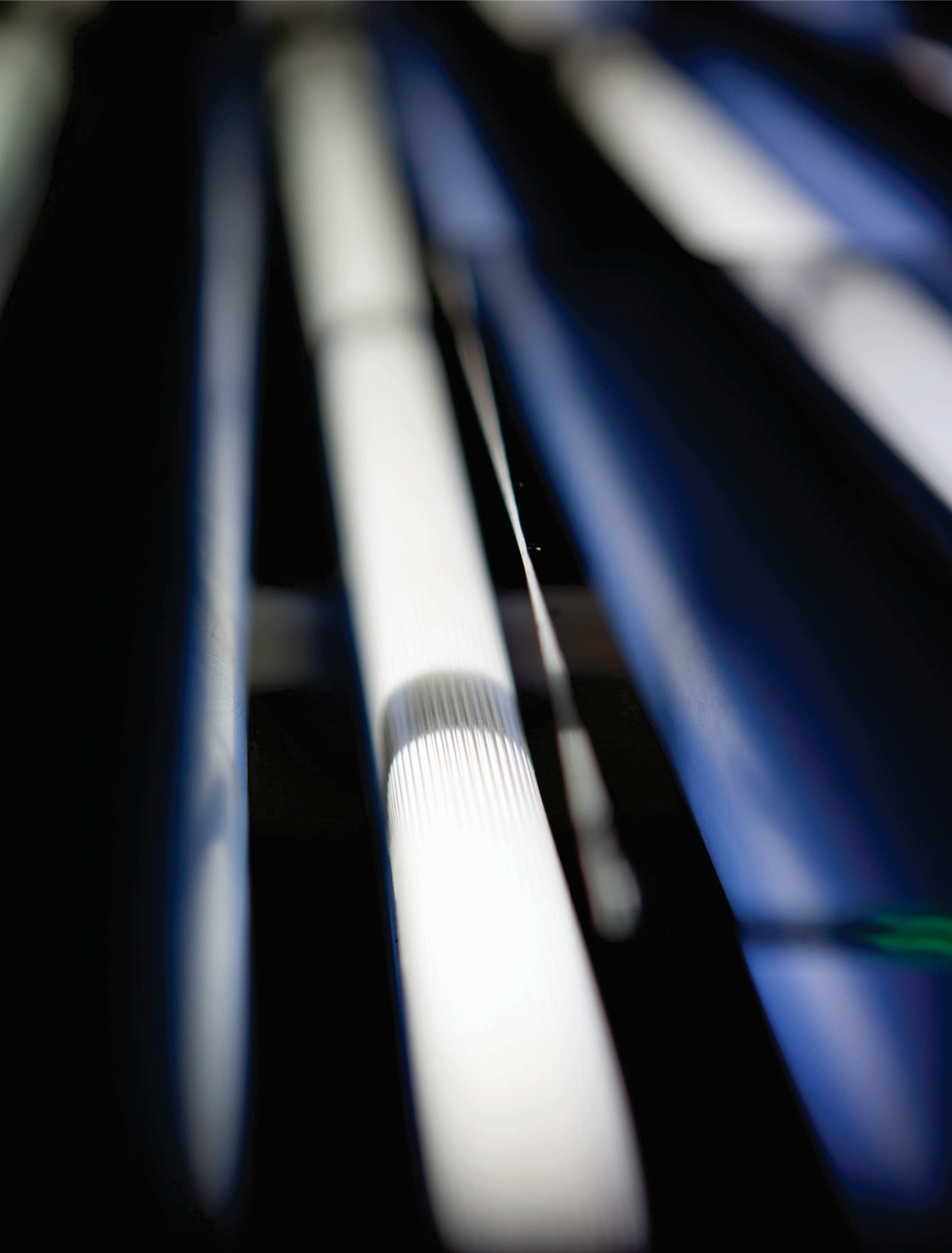

99 Spring Road • Tyseley • Birmingham B11 3DJ • England • UK ,  
Tel: +44 (0) 121 707 4343 • fax: +44 (0) 121 707 3535 ,  
Email: [cjk@bassra.com](mailto:cjk@bassra.com), [sales@bassra.com](mailto:sales@bassra.com) • Website [www.bassra.com](http://www.bassra.com)